

TANDEM™ MODULAR BLOCK

RETAINING & FREESTANDING WALL SYSTEMS

EASE AND FLEXIBILITY OF THE TANDEM SYSTEM,
NOW WITH A NEW METHOD OF INSTALLATION





TANDEM™ MODULAR BLOCK

RETAINING WALL SYSTEM

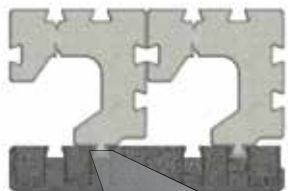
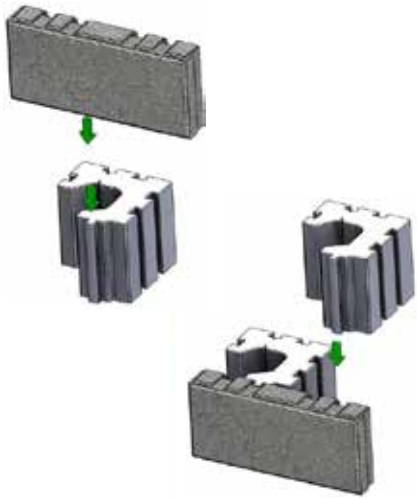

Tenon and mortise



RETAINING WALL

The Tandem Modular Block wall system allows construction of sloped retaining walls using the universal connector specially designed for this purpose. This connector is inserted in one of the two grooves located on the back of the structural units. The connectors are slid from the top of the grooves until they overlap the structure unit located below by roughly an inch.

In general, one universal connector is required for each structural unit. To create the necessary batter or setback, the connector must be placed as shown in the drawing. Simply push the Tandem Modular Block forward until the connector locks it. This will form a setback of roughly 3/8 inches relative to the lower unit.



STEP 1 - Slide the universal connector as follow (one connector per unit)



STEP 2 - Exceed the lower part of the connector with the units underneath



STEP 3 - Push the units forward until they lock

$\pm 3/8"$ (2.7 degrees)



Universal Connector



■ FREESTANDING WALL

The Tandem Modular Block wall system also allows construction of a double-sided wall that is built without a slope and thus is vertical.

Installation of a Tandem Modular Block double-sided wall requires the use of veneer units, which are affixed to each side of the Tandem Modular Block. The basic principle is to build a Tandem Modular Block wall and add veneer units in the back, affixing them with universal connectors in the vertical position. The outer corners of a double-sided wall must be built by using corner veneer units. The flexibility of the Tandem Modular Block system is based on the fact that the structural units can be positioned in several ways, ensuring that each veneer can be affixed to them by tenons or by universal connectors.

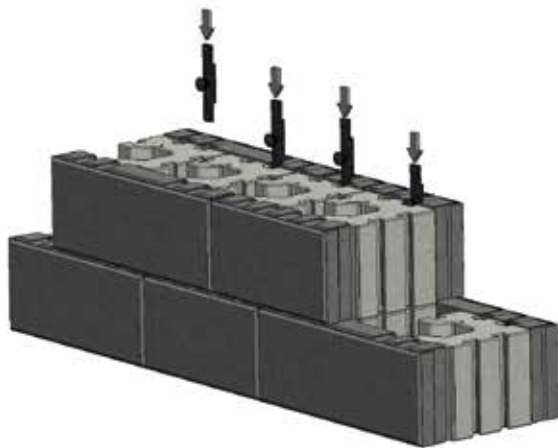

Slide the universal connector with complete insertion
(always have two connectors per veneer)



Universal Connector

TANDEM™ MODULAR BLOCK

FREESTANDING WALL SYSTEM

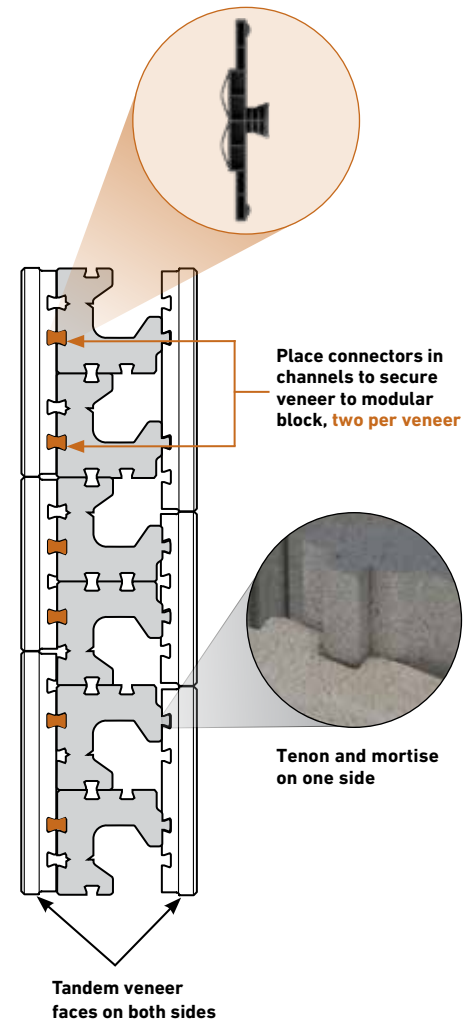

🔥 AVAILABLE FACE STYLES



ASHLAR



LAMINA



MELVILLE

🏗️ BLOCK FEATURES - REINFORCING WALLS

The maximum above-ground height of Tandem Modular Block retaining wall is 36 inches for a sloped wall and 22 inches for a vertical wall. A portion of the wall at least 6 inches high must be buried in the ground to ensure its stability.

The flexibility of the Tandem Modular Block system allows interconnection of structural units by using their tenon and mortise features. This has the advantage of being able to build stronger walls by adding units in the back.

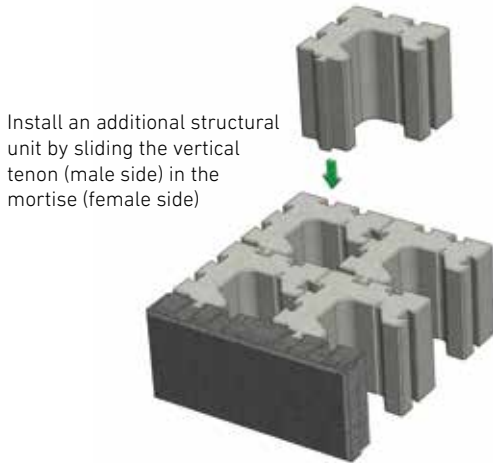

Install an additional structural unit by sliding the vertical tenon (male side) in the mortise (female side)

Easily install additional structural units to reinforce the corner

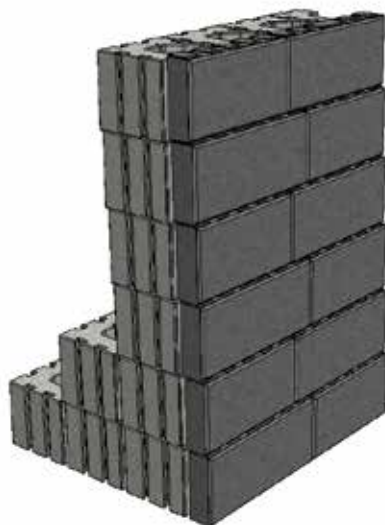
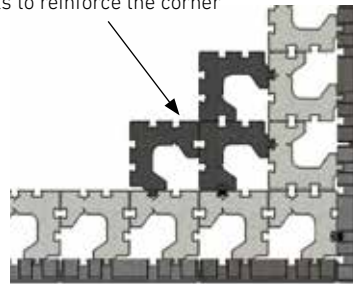

Achieve higher gravity wall heights by connecting units together

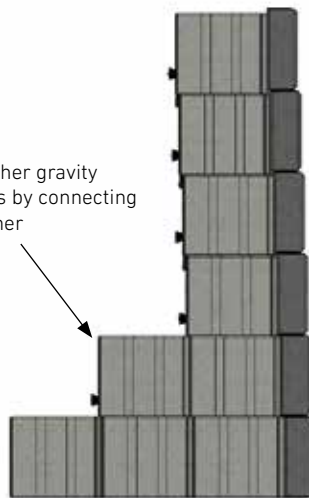

TANDEM™ MODULAR BLOCK

RETAINING & FREESTANDING
WALL SYSTEMS

EASE AND FLEXIBILITY OF THE
TANDEM SYSTEM, NOW WITH A
NEW METHOD OF INSTALLATION

🕒 FEATURES & BENEFITS

- Three different veneer face styles.
- Design flexibility.
- Better stability during installation.
- Limited job site space solution.
- Connecting multiple blocks together to reinforce to make a higher wall without geogrid.
- Easily construct reinforced corners by connecting multiple blocks.
- One all-purpose plastic connector; retaining wall, double faced wall, setback wall, corners, curved wall and columns.

📦 SHAPES & SIZES

TANDEM MODULAR BLOCK



7¹/₁₆ x 7⁷/₈ x 7⁷/₈

UNIVERSAL CONNECTOR*



5³/₄ x 1¹/₄ x 7⁷/₈

*Box of 148 units. 1 box of 4 bags of 37 units. 27 boxes/cube